

SIDES	BOTTOM
Material: Steel-0.0625"-G60 Galvanized	

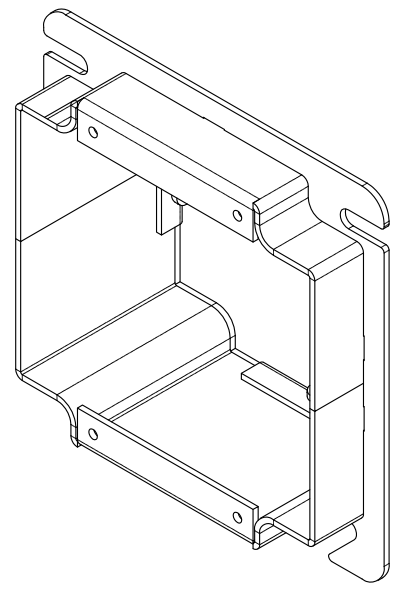
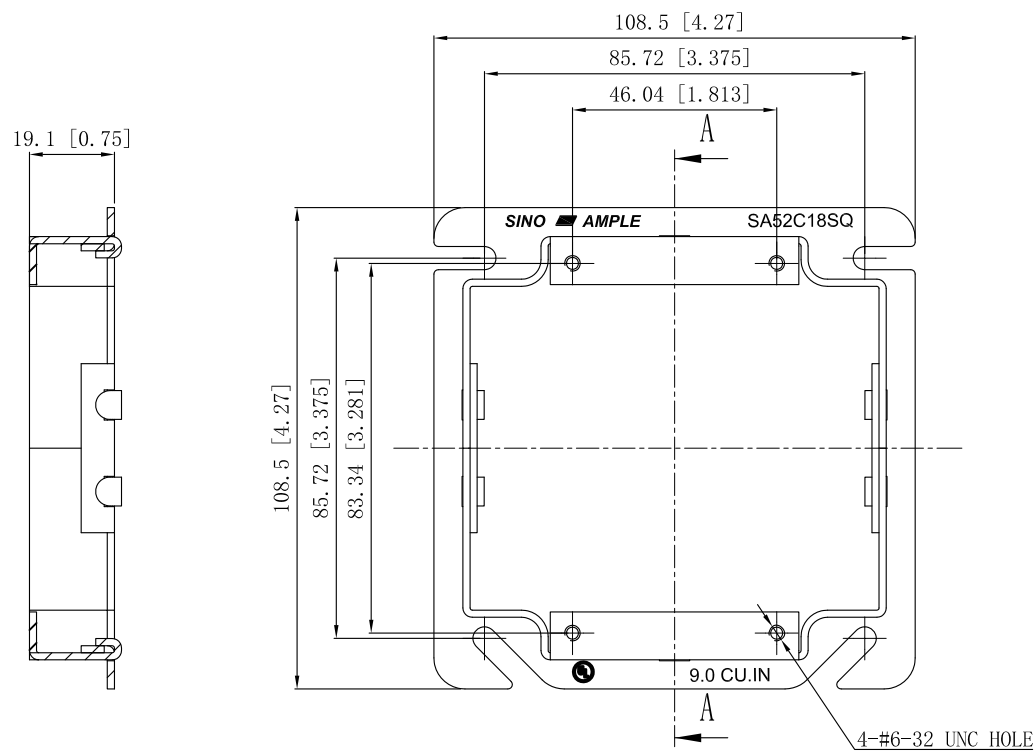

CUTAWAY VIEW A-A

This data sheet is for reference only . SINO AMPLE reserves the right to make changes to the design without prior notice.

DESCRIPTION
TRADE REFERENCE TERMS

STANDARD PACKING	ZHUJI SINO AMPLE METAL PRODUCTS CO. , LTD.		
25 PCS	TITLE 4" SQUARE TWO-GANG DEVICE TILE COVERS		
	SIZE A4	DWG NO. SA52C18SQ	REV A
	DATA SHEET		