

SIDES	BOTTOM
1 PCS #5/16-18 Hex Nut Installed	
1 PCS #5/16-18×1-1/4 Screws Installed	
Material:Steel-0.0866"-G60 Galvanized	

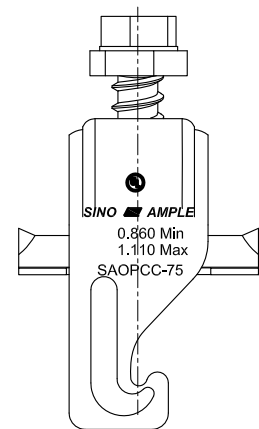
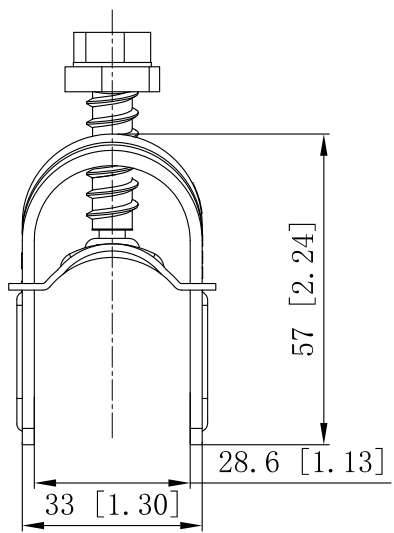
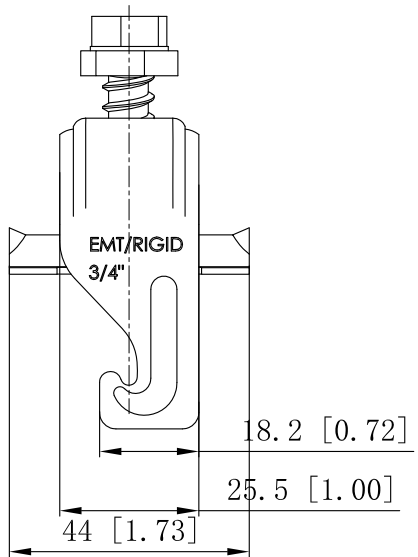
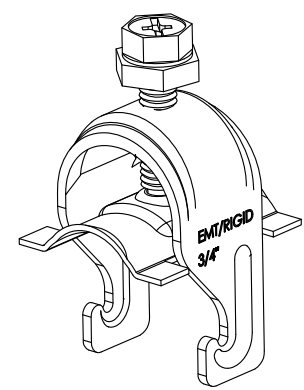
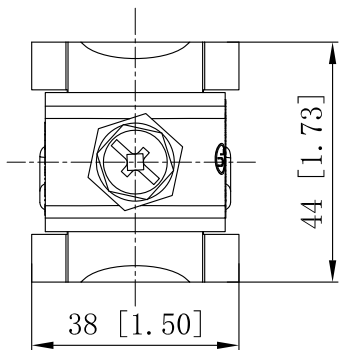

This data sheet is for reference only .SINO AMPLE reserves the right to make changes to the design without prior notice.

DESCRIPTION
TRADE REFERENCE TERMS

STANDARD PACKING	ZHUJI SINO AMPLE METAL PRODUCTS CO., LTD.		
	TITLE One Piece Strut Clamp		
SIZE A4	DWG NO. SAOPCC-75	REV A	
DATA SHEET			