

SIDES	BOTTOM
Material: Steel-0.0625"-G60 Galvanized	

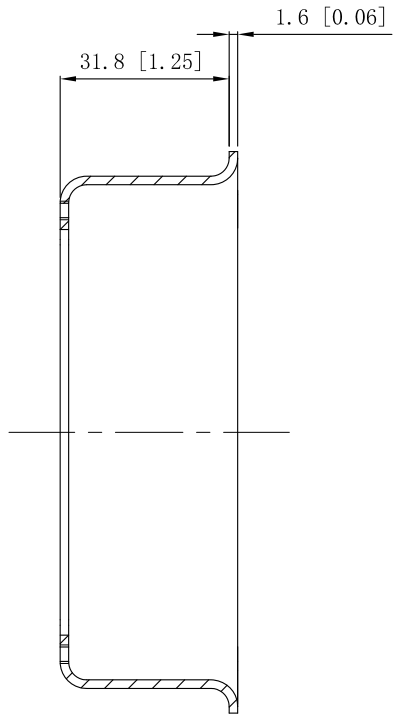

CUTAWAY VIEW A-A

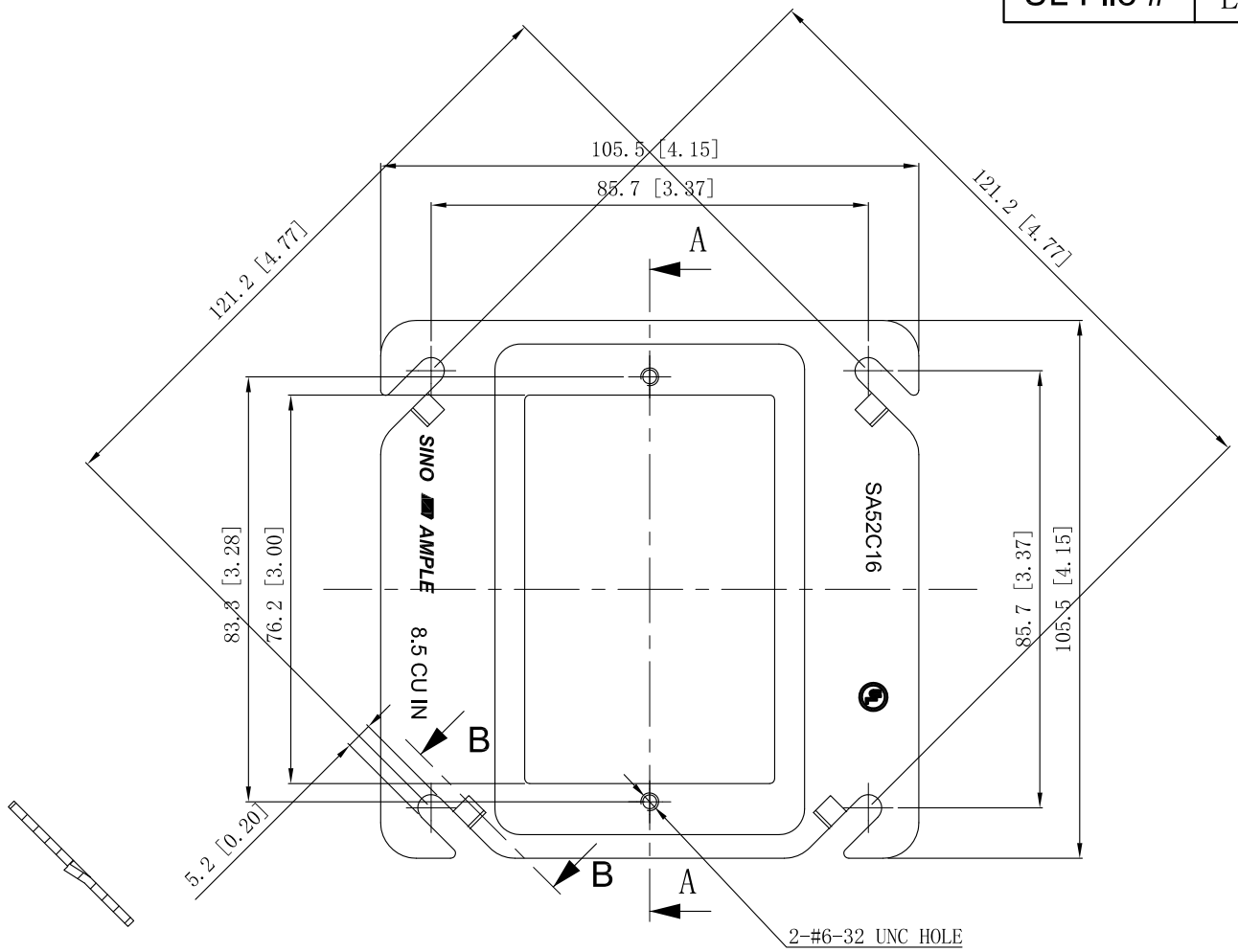

CUTAWAY VIEW B-B

This data sheet is for reference only .SINO AMPLE reserves the right to make changes to the design without prior notice.

DESCRIPTION
TRADE REFERENCE TERMS

STANDARD PACKING	ZHUJI SINO AMPLE METAL PRODUCTS CO., LTD.		
25 PCS	TITLE 4" SQUARE 1-DEVICE COVERS (PLASTER/MUD RINGS)		
	SIZE A4	DWG NO. SA52C16	REV A
DATA SHEET			