

SIDES	BOTTOM
Material:Steel-0.0625"-G60 Galvanized	

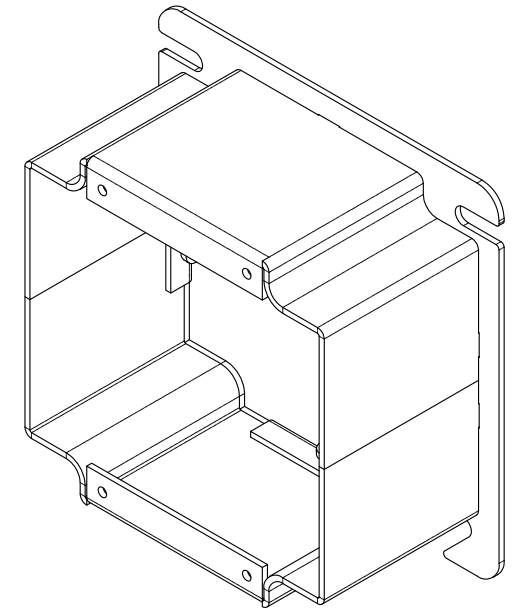
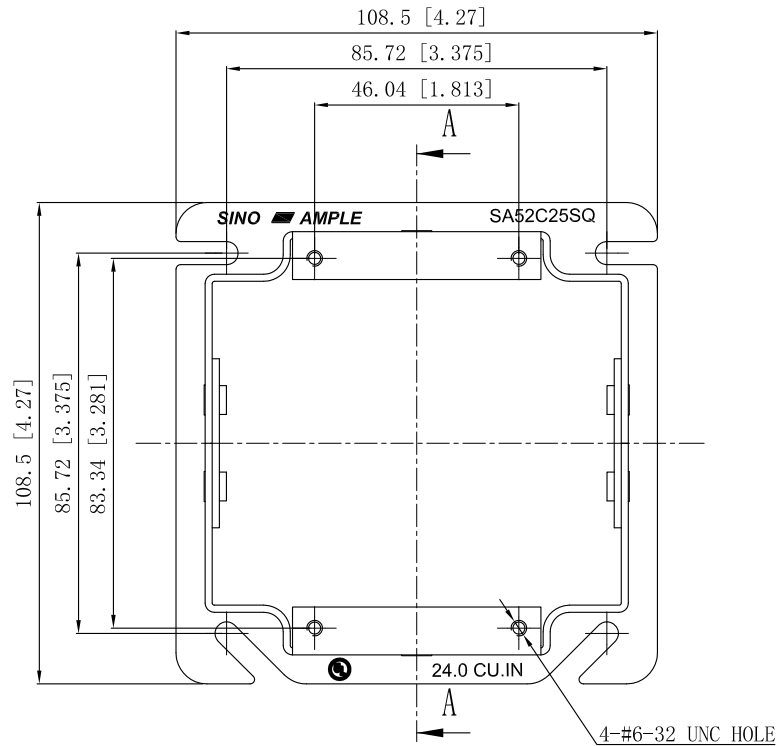
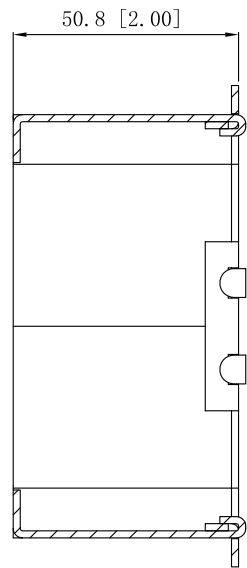
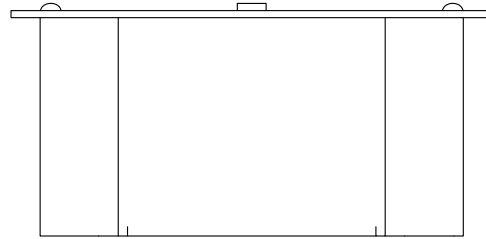

CUTAWAY VIEW A-A

This data sheet is for reference only .SINO AMPLE reserves the right to make changes to the design without prior notice.

DESCRIPTION
TRADE REFERENCE TERMS

STANDARD PACKING	ZHUJI SINO AMPLE METAL PRODUCTS CO., LTD.		
25 PCS	TITLE 4" SQUARE TWO-GANG DEVICE TILE COVERS		
	SIZE A4	DWG NO. SA52C25SQ	REV A
	DATA SHEET		